

**SLIDING - HINGED
DOORS & WINDOWS**

SLIDING DOORS&WINDOS { PS6600 }

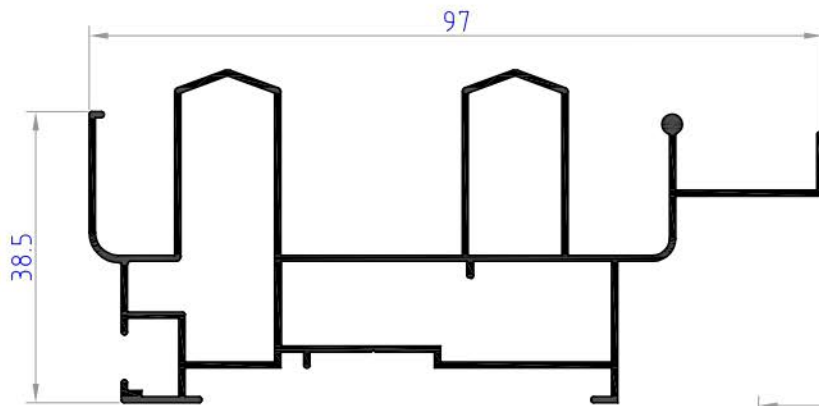

PS6622
weight 0.780 kg/ml

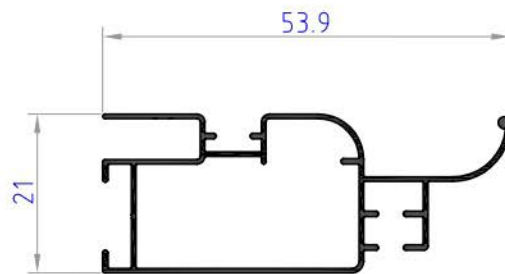

PS6006
weight 0.368 kg/ml

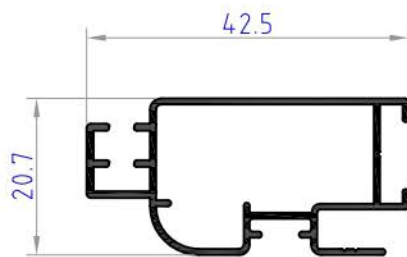

PS6606
weight 0.322 kg/ml

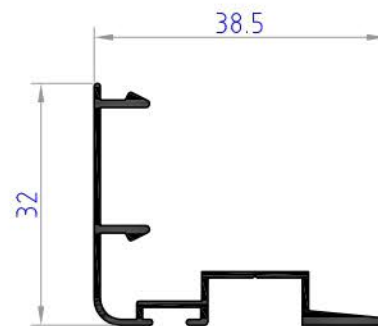

PS6603
weight 0.253 kg/ml

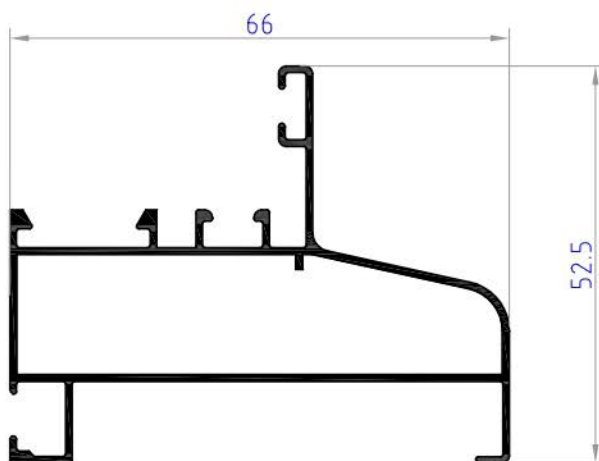

PS6648
weight 0.610 kg/ml

SLIDING DOORS&WINDOS { PS6600 }

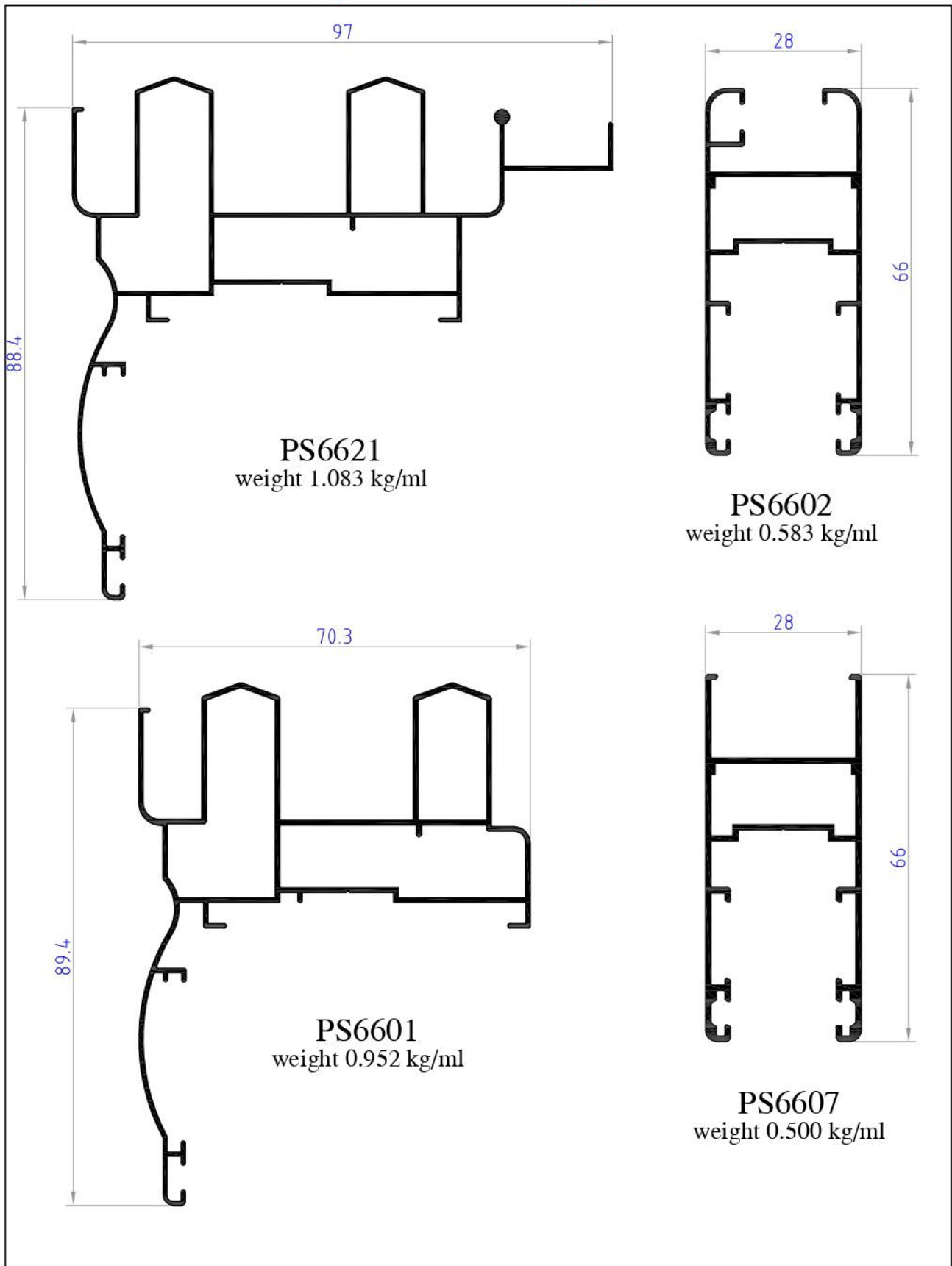

SLIDING DOORS & WINDOWS { PS9600 }

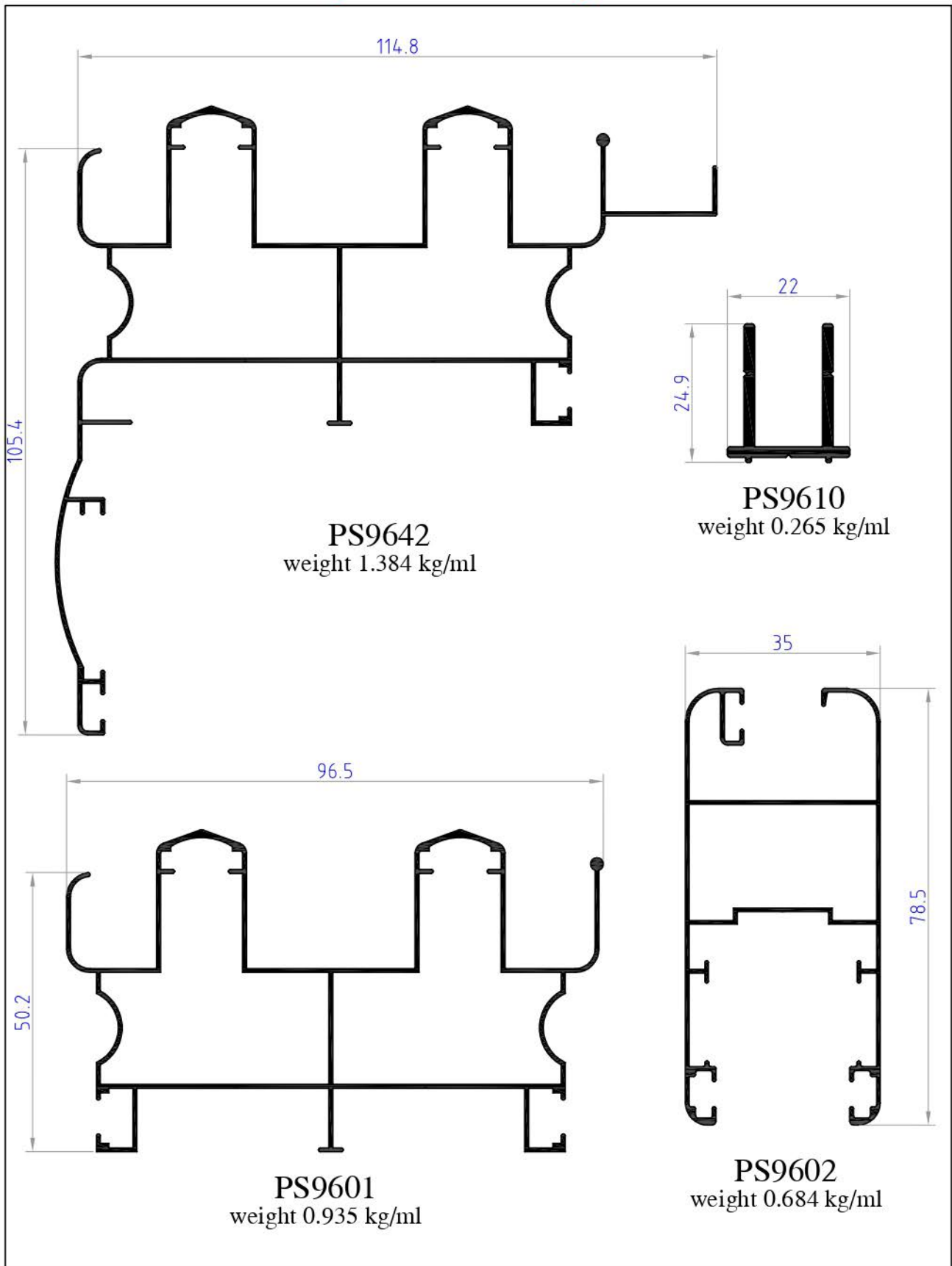



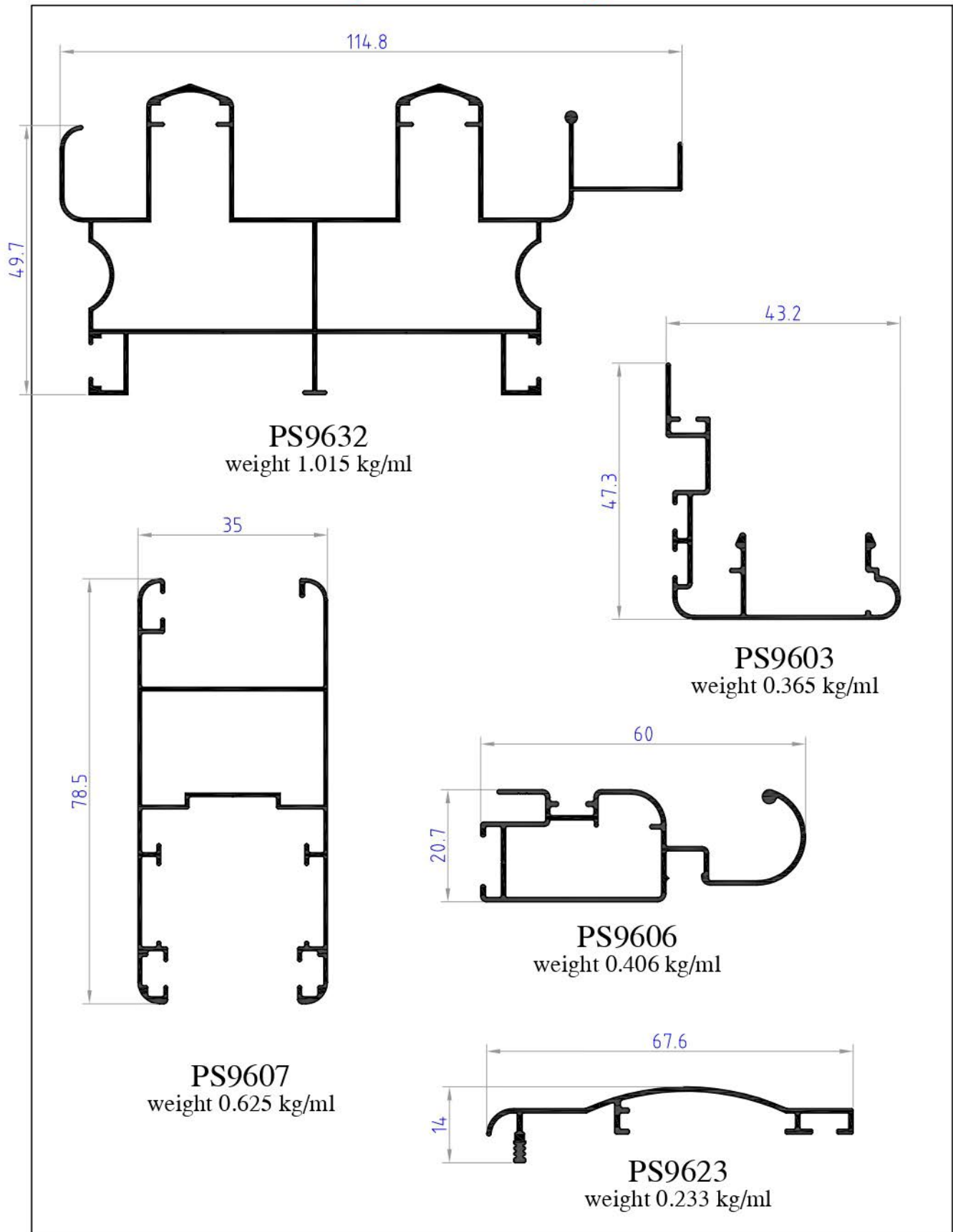

SLIDING DOORS&WINDOS { PS9600 }

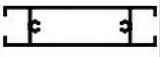
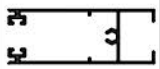
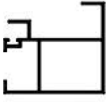
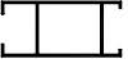
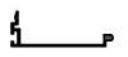
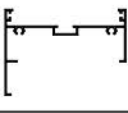
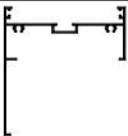
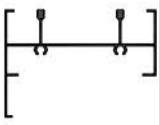
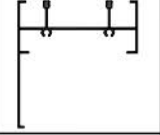

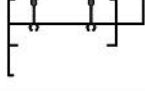
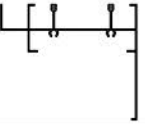
NC80

PROFILE NO.	SECTION	WEIGHT kg/ml
NC1210		0.619
NC1216		0.538
NC1219		0.379
NC1221		0.314
NC1285		0.168
NC1339		0.518
NC1339A		0.690
NC1340		0.573
NC1340A		0.618

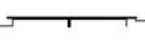
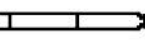
PROFILE NO.	SECTION	WEIGHT kg/ml
NC2322		0.685
NC2322A		0.832
NC1517		0.145
NC1515		0.258
NC5504		0.252
AM116		0.240
C10		0.273
C11		0.512

SLIDING DOORS & WINDOWS { NC80 }

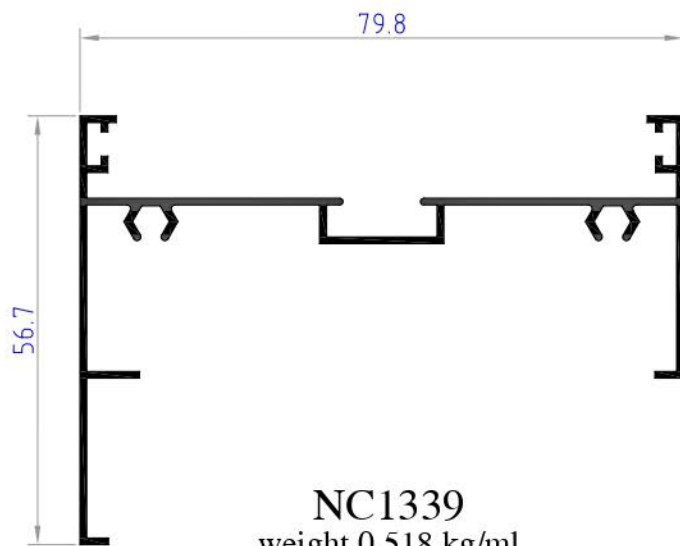

NC1339
weight 0.518 kg/ml

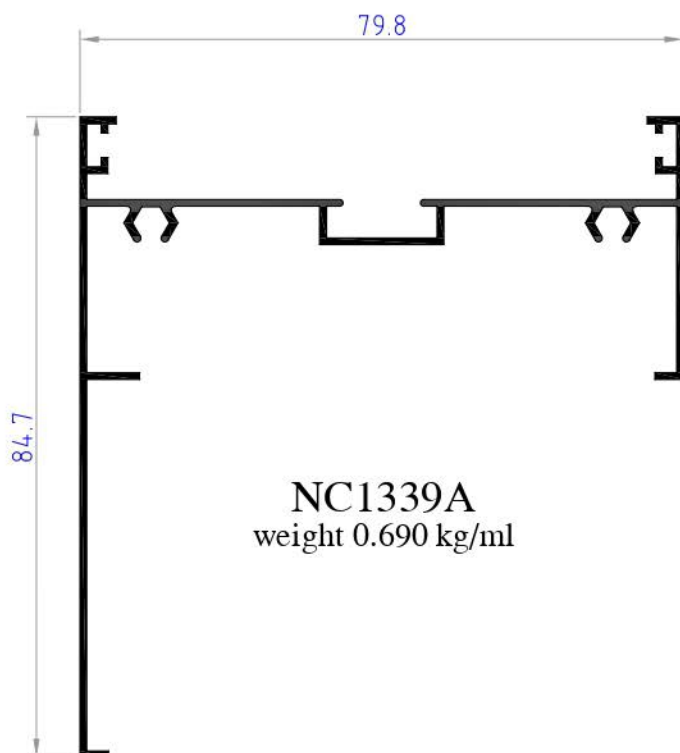

NC1339A
weight 0.690 kg/ml

SLIDING DOORS & WINDOWS { NC80 }

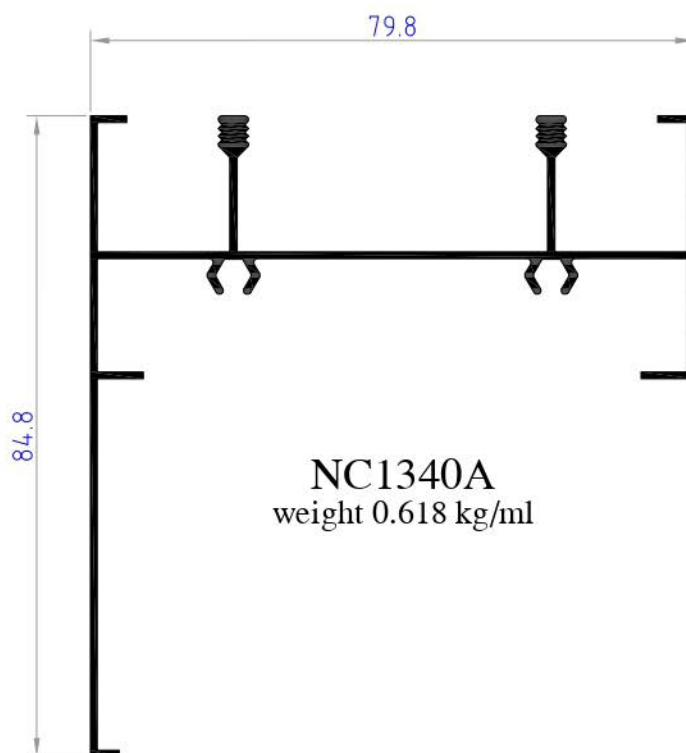
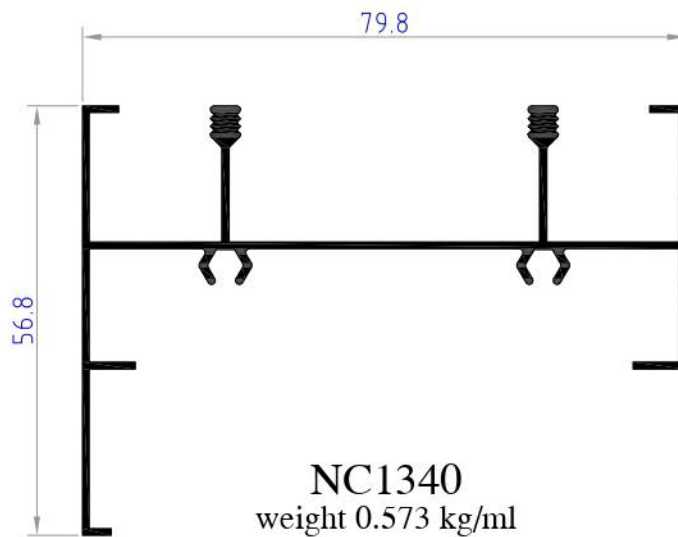

SLIDING DOORS & WINDOWS { NC80 }

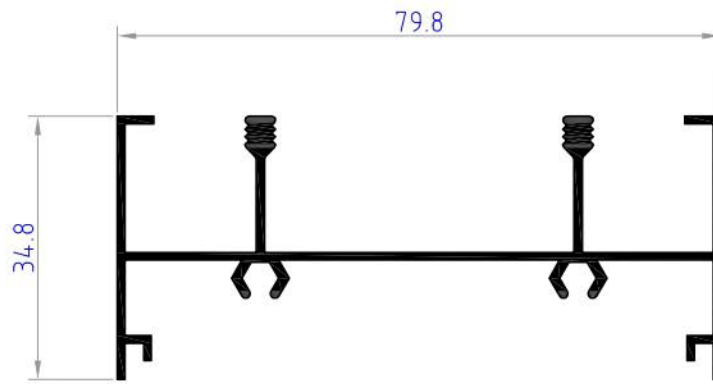

NC1227
weight 0.630 kg/ml

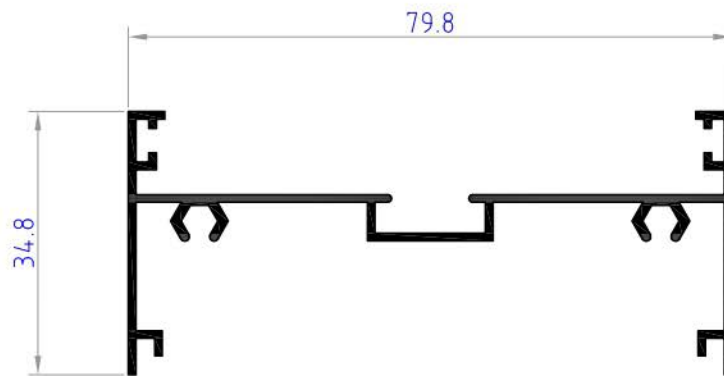

NC1228
weight 0.540 kg/ml

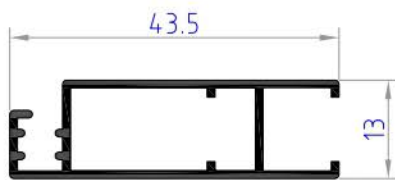

NC1515
weight 0.258 kg/ml

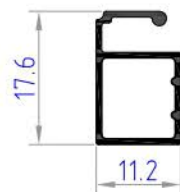

NC1517
weight 0.145 kg/ml

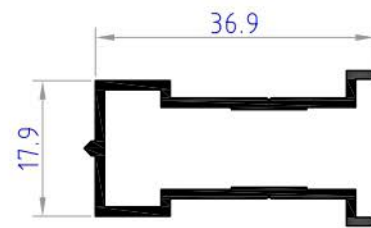

AM116
weight 0.240 kg/ml

SLIDING DOORS & WINDOWS { NC80 }

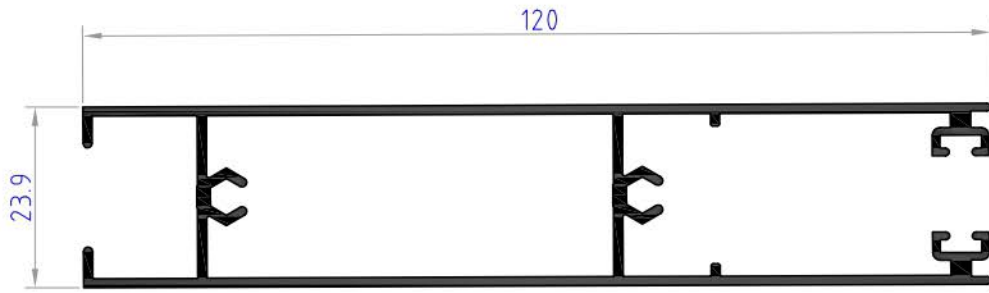

NC1215
weight 0.950 kg/ml

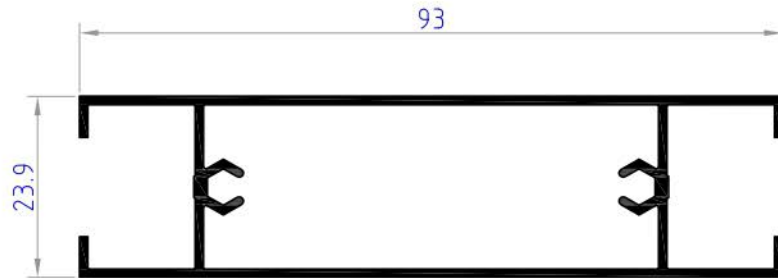

NC1210
weight 0.619 kg/ml

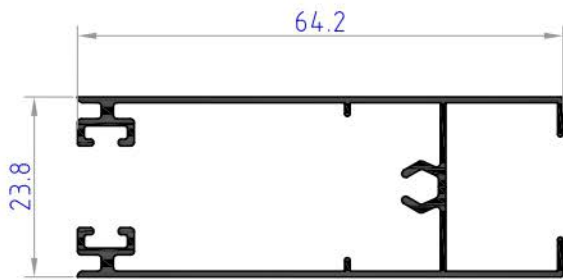

NC1216
weight 0.538 kg/ml

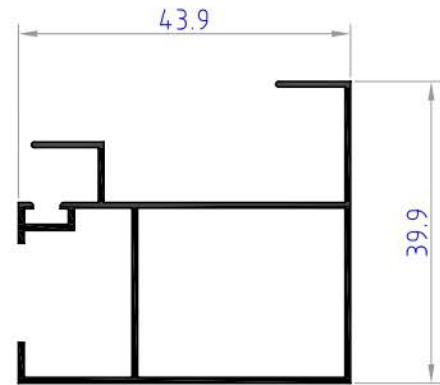

NC1219
weight 0.379 kg/ml

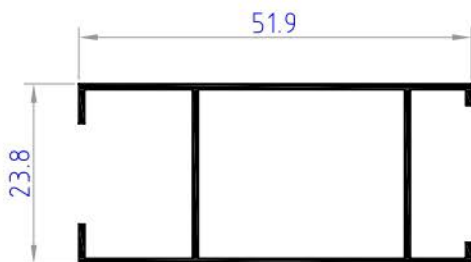

NC1221
weight 0.314 kg/ml

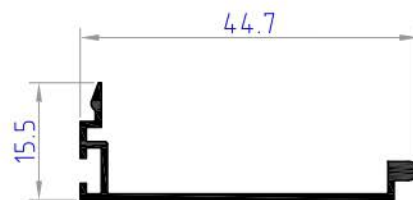

NC1285
weight 0.168 kg/ml

SLIDING DOORS & WINDOWS { NC80 }

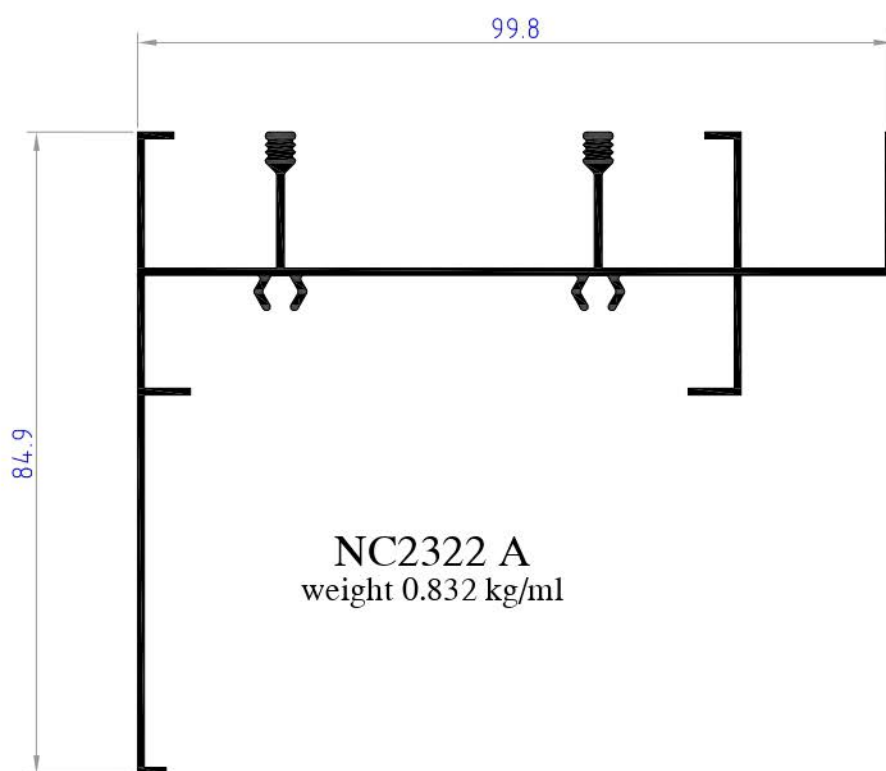
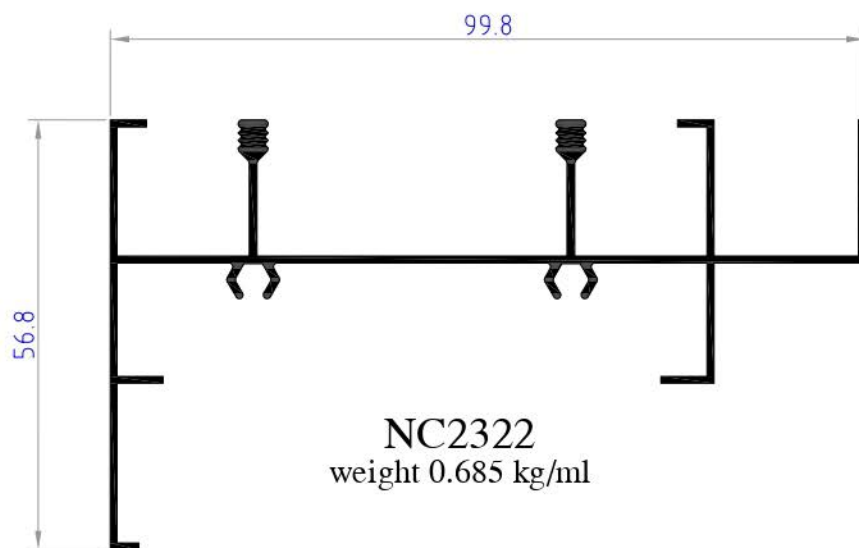

SLIDING DOORS&WINDOS

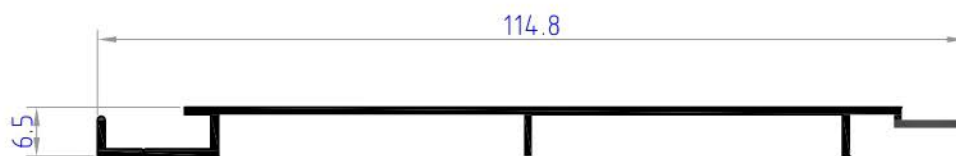

C10
weight 0.273 kg/ml

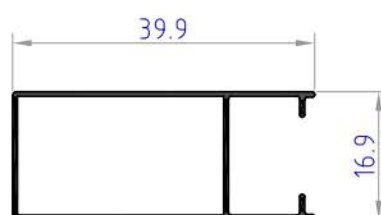

NC5504
weight 0.252 kg/ml

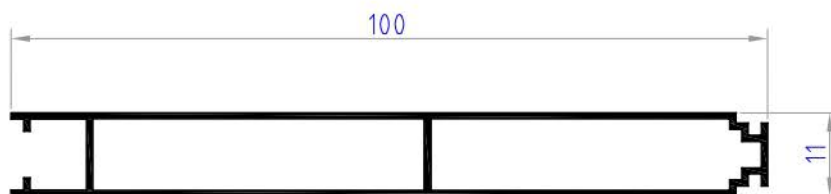

C11
weight 0.512 kg/ml

HINGED DOORS & WINDOWS { PS4800 }

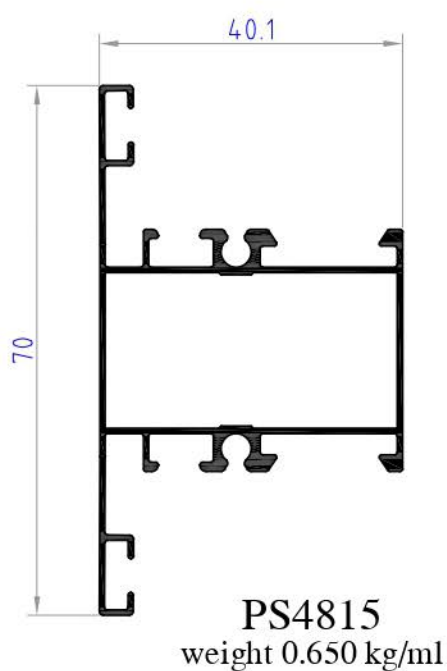
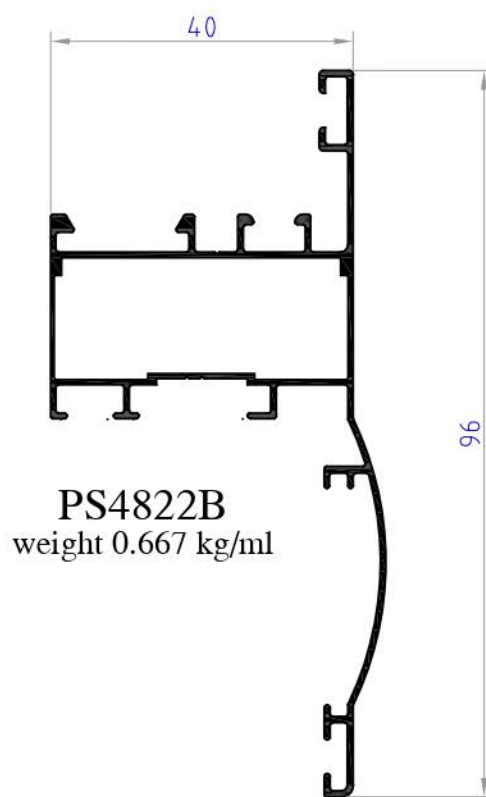
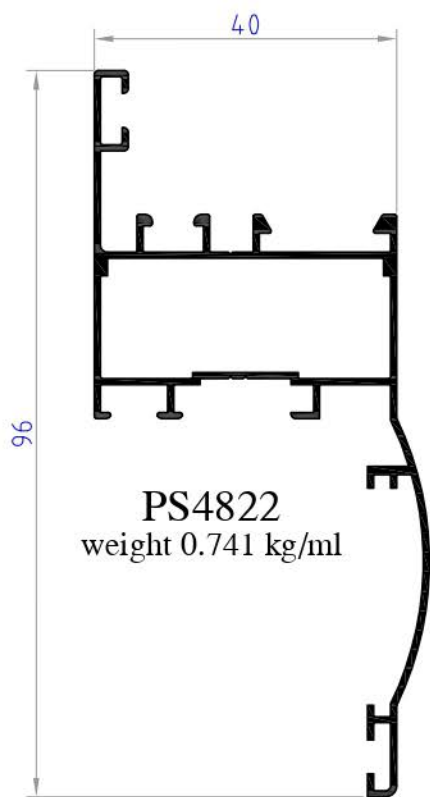

HINGED DOORS & WINDOWS { PS4800 }

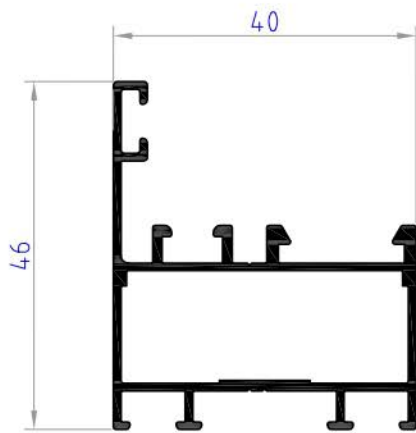

PS4805
weight 0.432 kg/ml

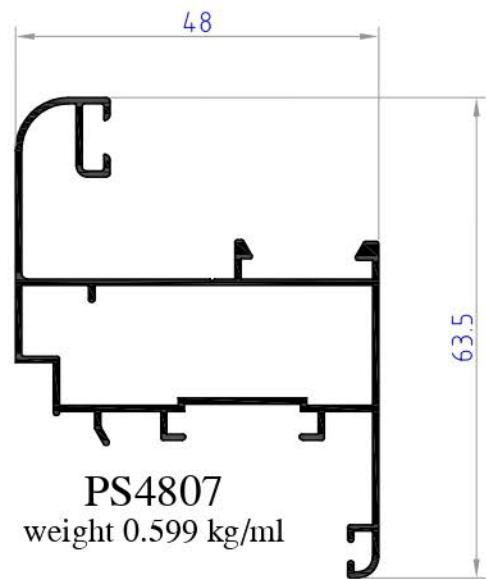

PS4807
weight 0.599 kg/ml

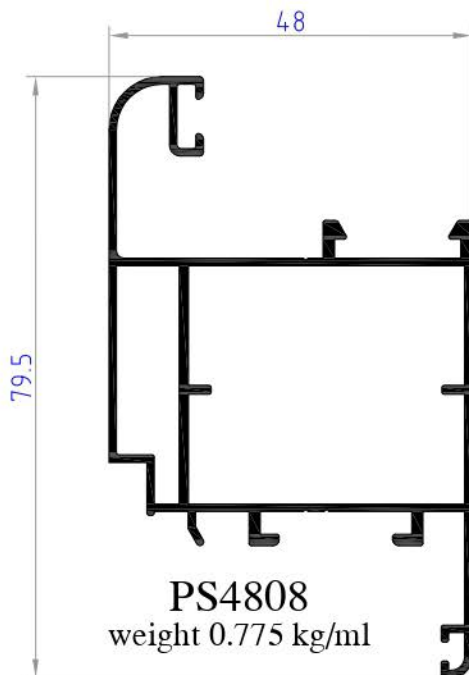

PS4808
weight 0.775 kg/ml

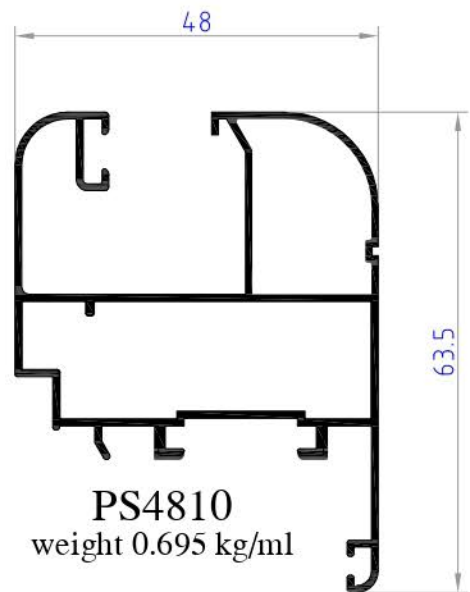

PS4810
weight 0.695 kg/ml

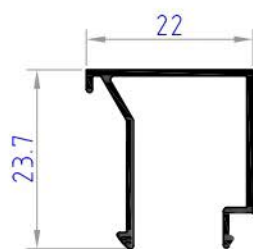

PS4811
weight 0.160 kg/ml

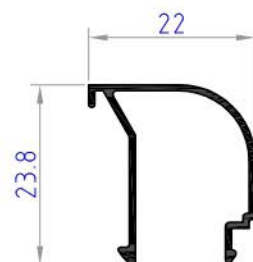

PS4812
weight 0.157 kg/ml

HINGED DOORS & WINDOWS { PS4800 }

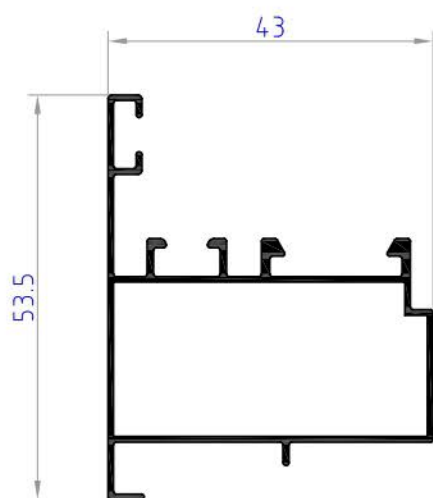

PS4809
weight 0.457 kg/ml

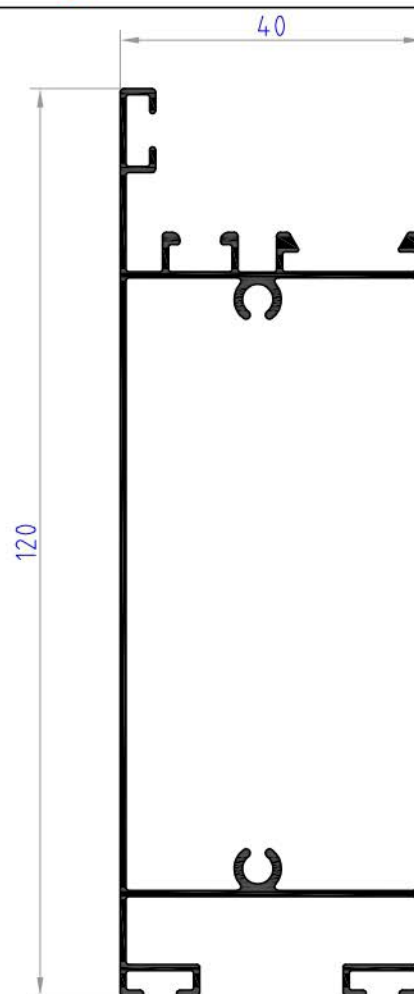

PS4817
weight 0.842 kg/ml

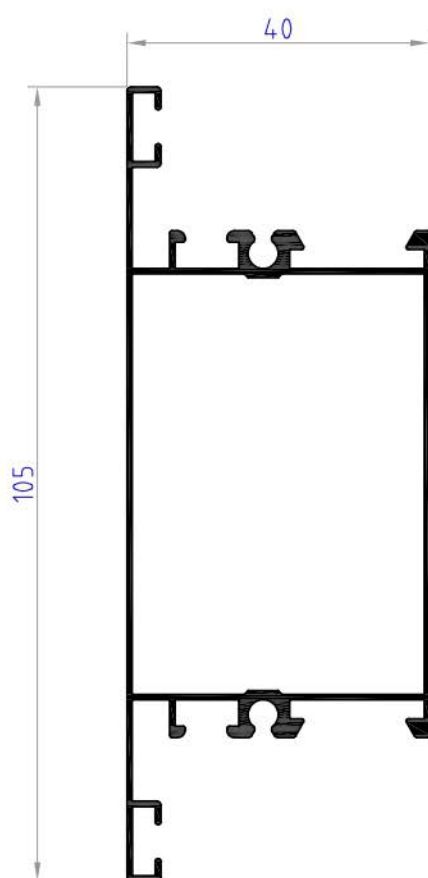

PS4816
weight 0.823 kg/ml

HINGED DOORS&WINDOS { PS5600 }

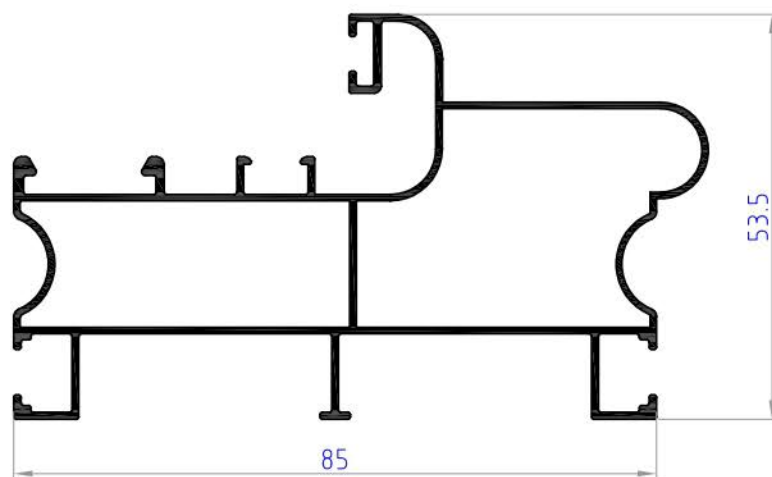

PS5606
weight 0.892 kg/ml

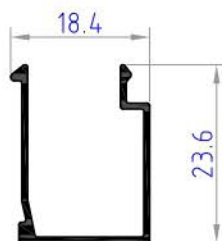

PS5613
weight 0.147 kg/ml

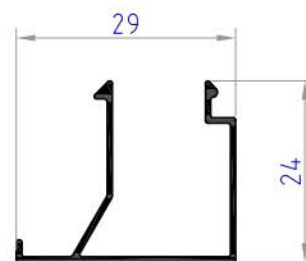

PS5611
weight 0.167 kg/ml

SLIDING DOORS & WINDOWS { NC40 }

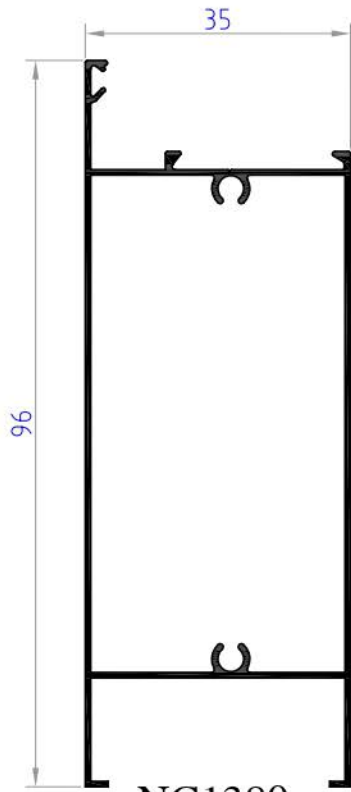

NC1380
weight 0.860 kg/ml

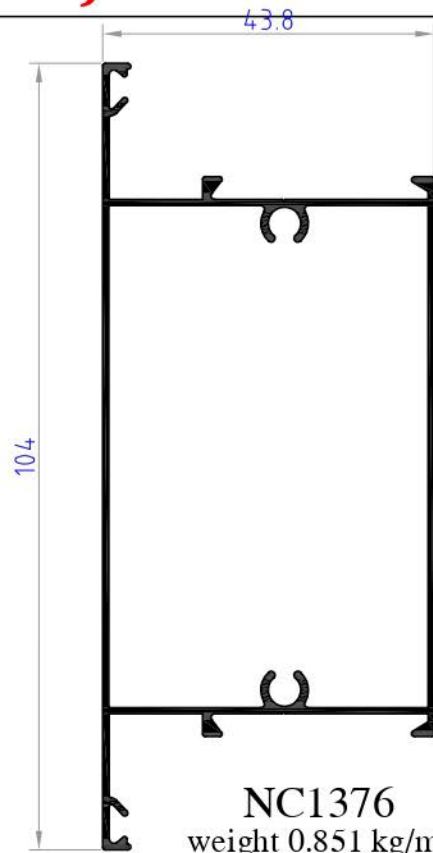

NC1376
weight 0.851 kg/ml

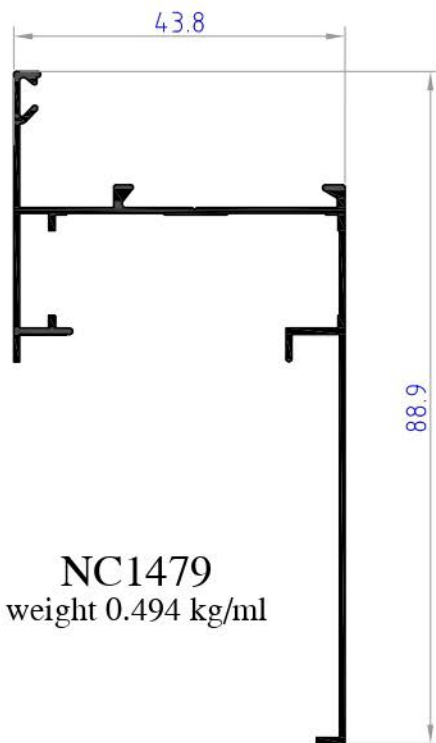

NC1479
weight 0.494 kg/ml

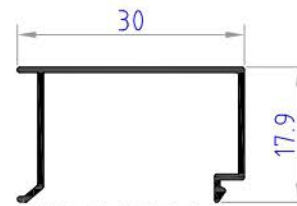

NC1374
weight 0.149 kg/ml

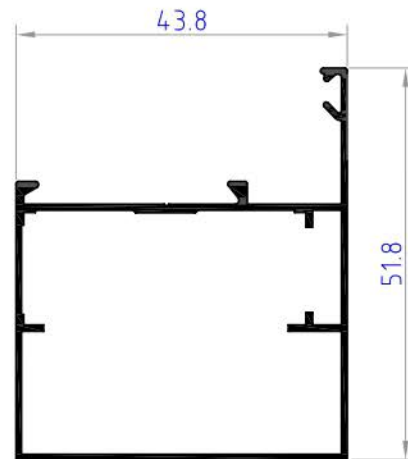

NC1409
weight 0.495 kg/ml

SLIDING DOORS & WINDOWS { NC40 }

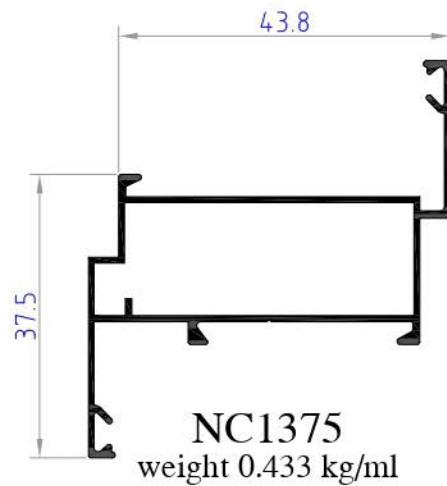
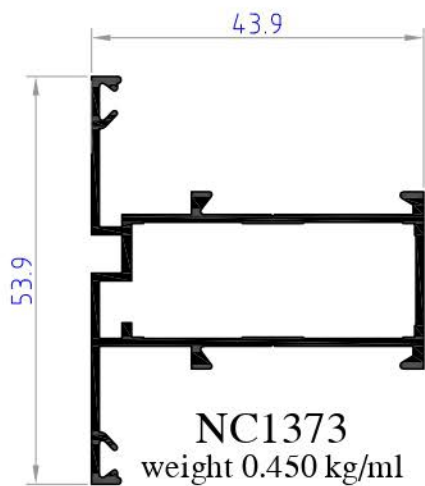
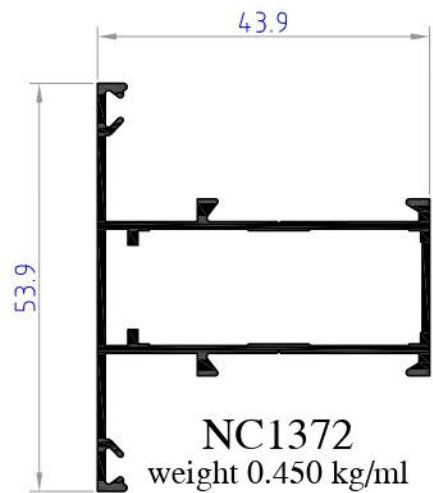
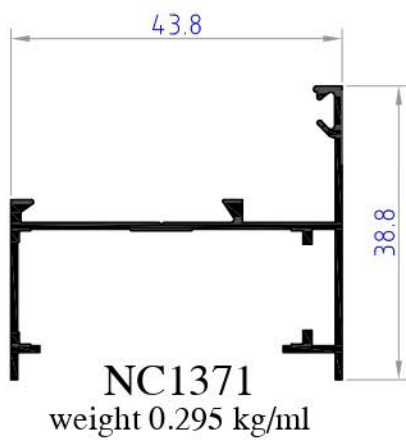
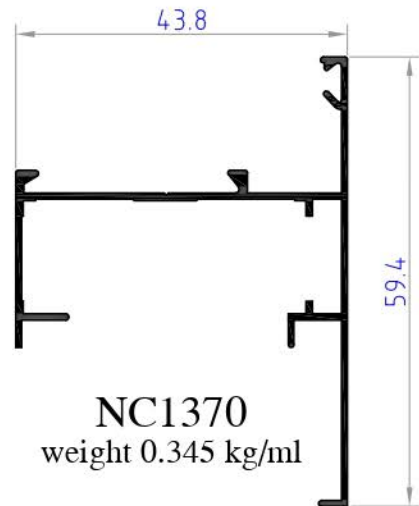
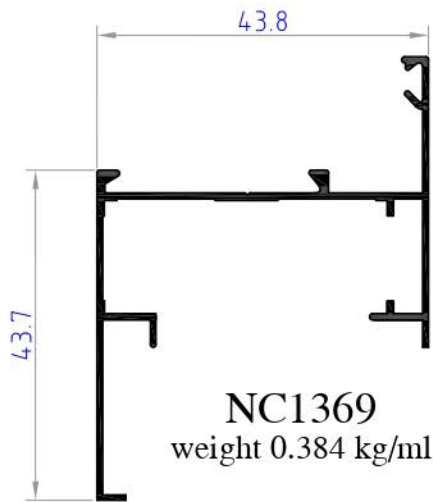

HINGED DOORS & WINDOWS { NC40 }

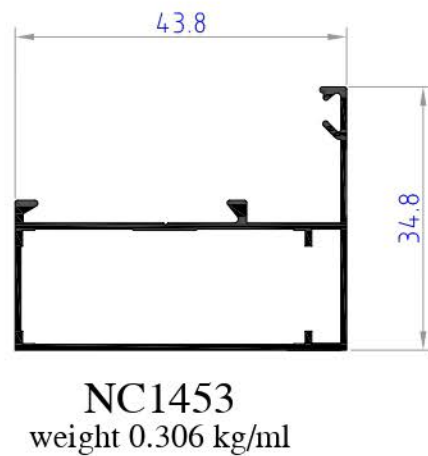
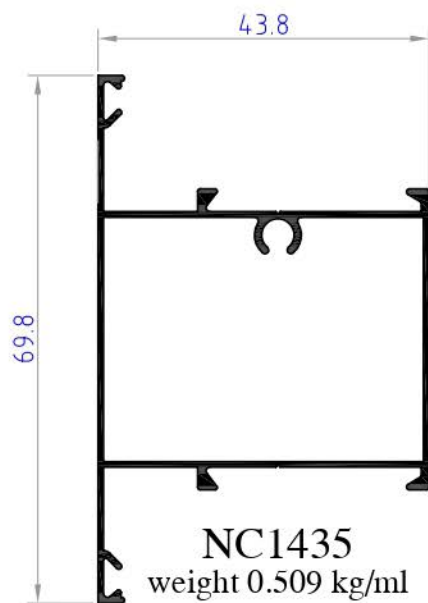
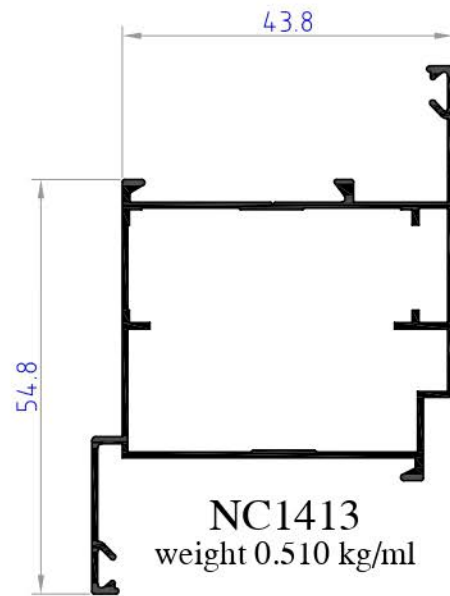
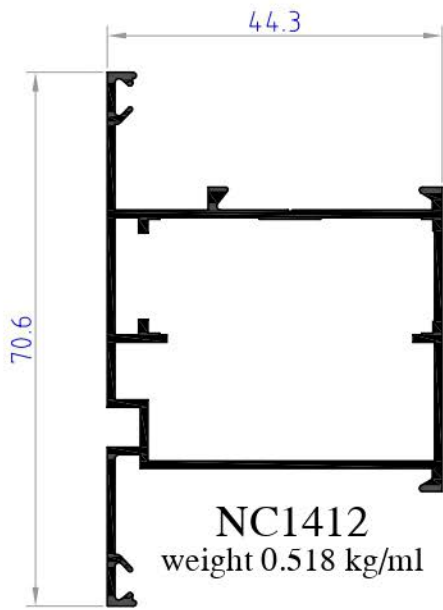

SLIDING DOORS&WINDOS

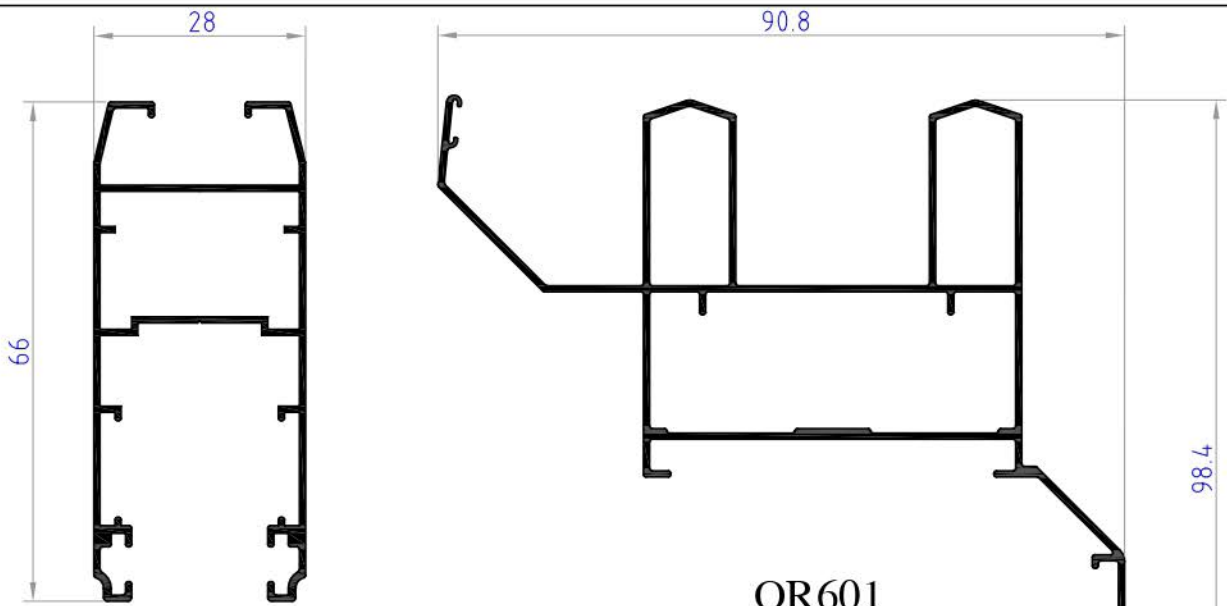

OR602
weight 0.647 kg/ml

OR601
weight 0.915 kg/ml

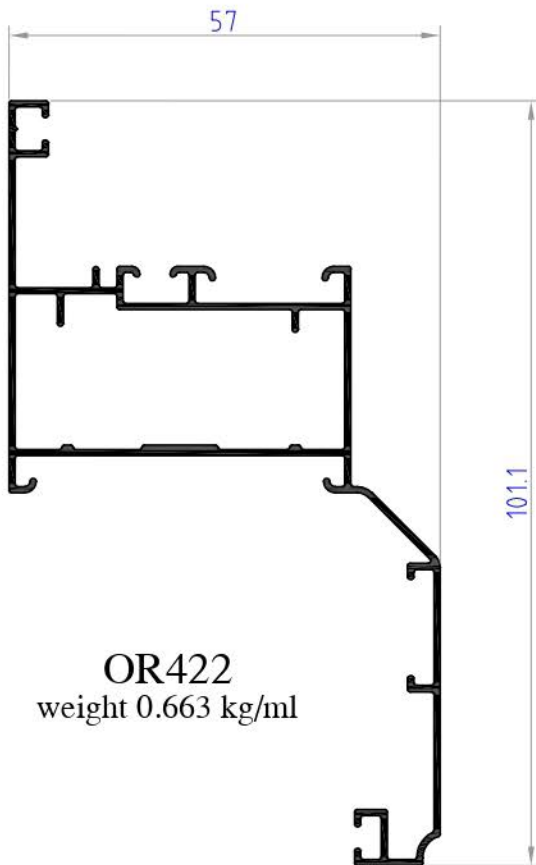

OR422
weight 0.663 kg/ml

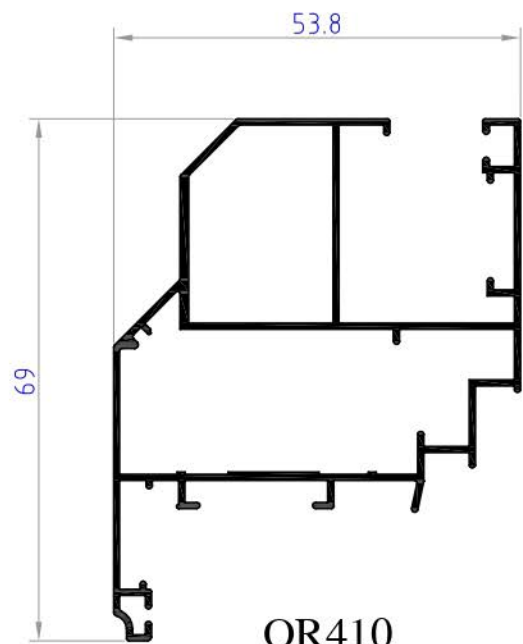

OR410
weight 0.733 kg/ml

SLIDING DOORS&WINDOS

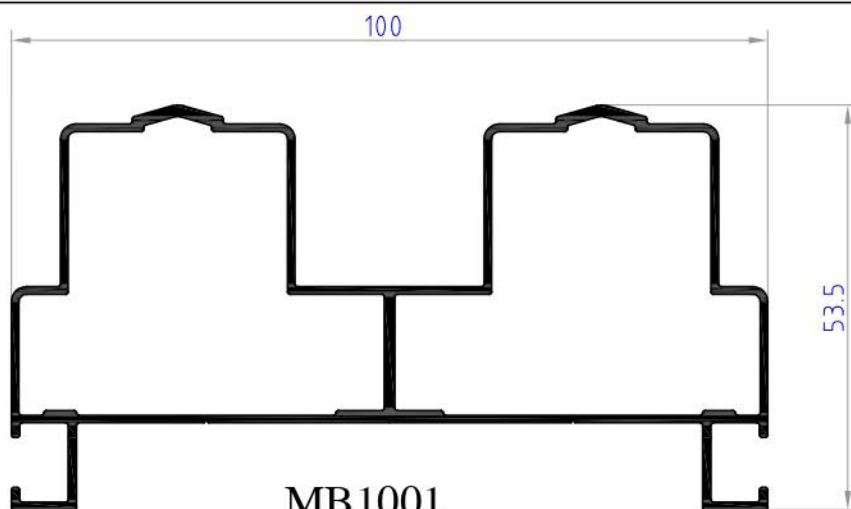

MB1001
weight 1.068 kg/ml

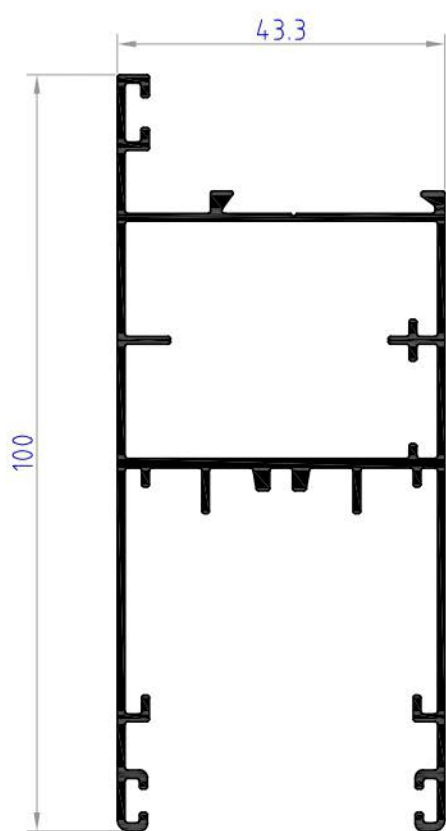

MB1002
weight 0.937 kg/ml