

**OFFICE
FURNITURE
PROFILES**

OFFICE FURNITURE PROFILES

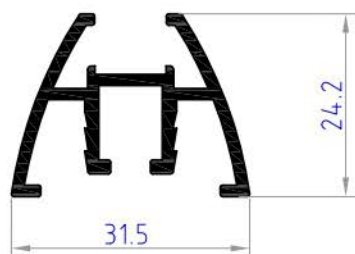

TRN 02
weight 0.368 kg/ml

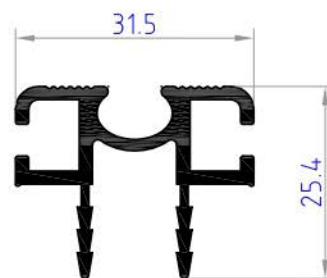

TRN 01
weight 0.538 kg/ml

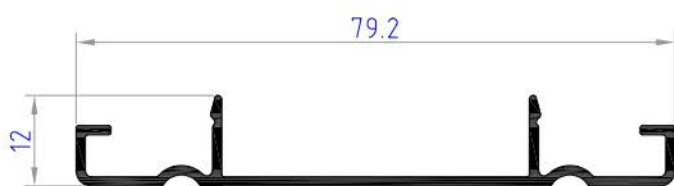

TRN 04
weight 0.391 kg/ml

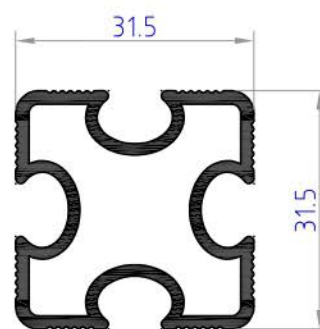

TRN 03
weight 0.473 kg/ml

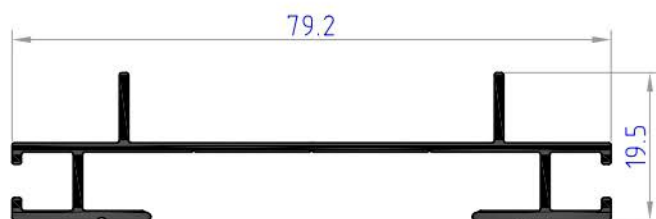

TRN 05
weight 0.496 kg/ml

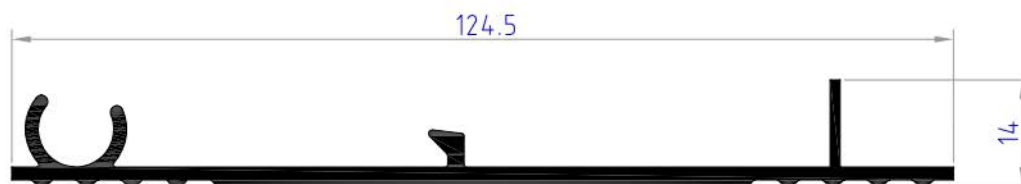

TRN 06
weight 0.709 kg/ml

OFFICE FURNITURE PROFILES

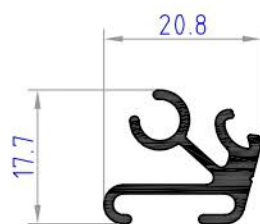

TRN 08
weight 0.322 kg/ml

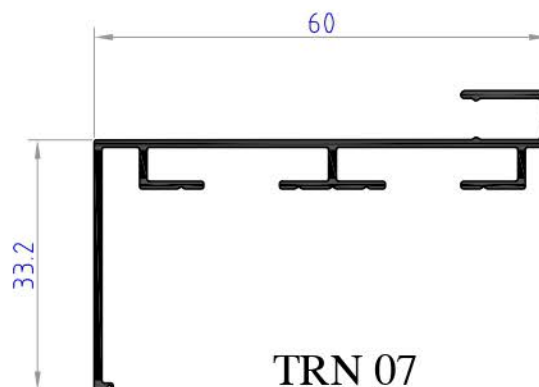

TRN 07
weight 0.397 kg/ml

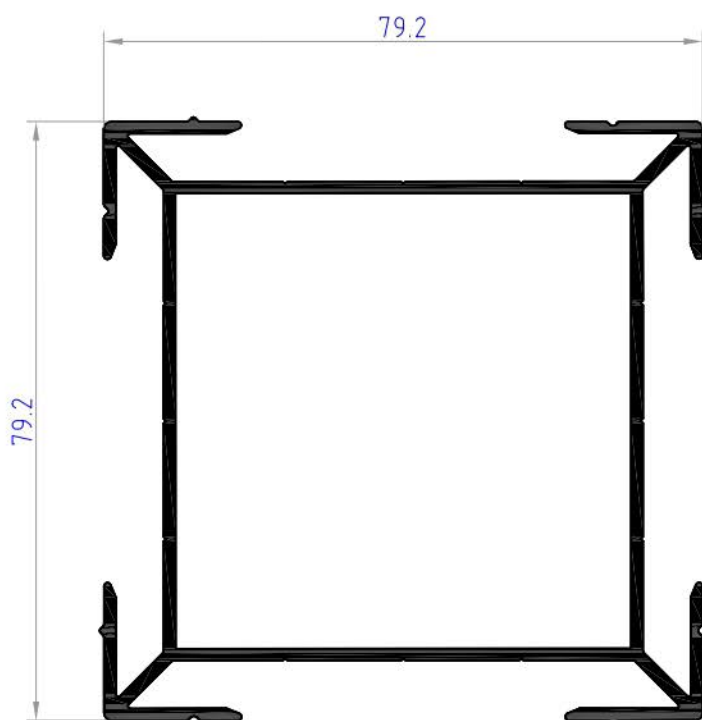



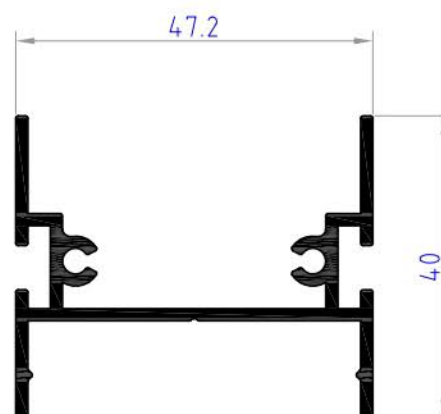







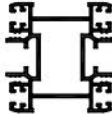
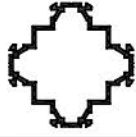
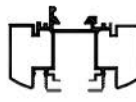

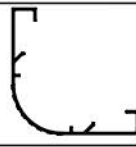

TRN 10
weight 1.533 kg/ml

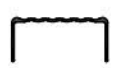

TRN 09
weight 0.665 kg/ml

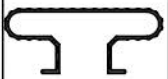
OFFICE FURNITURE PROFILES

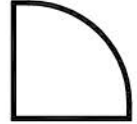
PROFILE NO.	SECTION	WEIGHT kg/ml
FUT-23		0.641
FUT-24		0.584
FUT-25		1.165
FUT-26		1.391
FUT-27		2.522
FUT-28		2.138
FUT-29		0.780
FUT-30		0.796
FUT-31		0.940

PROFILE NO.	SECTION	WEIGHT kg/ml
FR01		0.631
FR02		0.633
FR03		0.443
FR04		0.906
MSD-01		0.049
MY-02		0.096
MY-03		0.085
6016B		0.065
CH-01		1.293
CH-02		0.641

OFFICE FURNITURE PROFILES

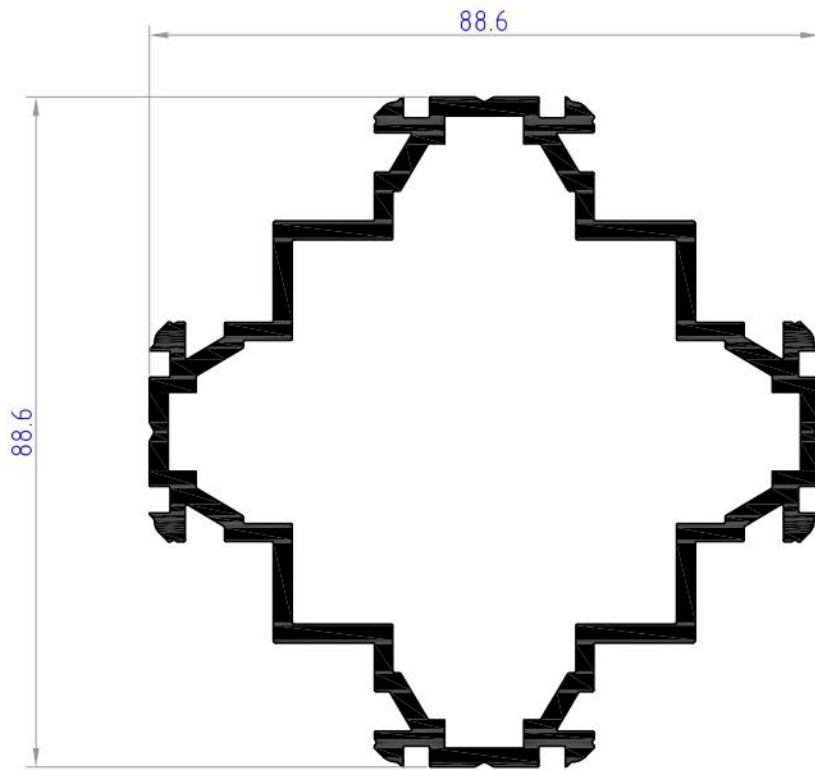

FUT 27
weight 2.522 kg/ml

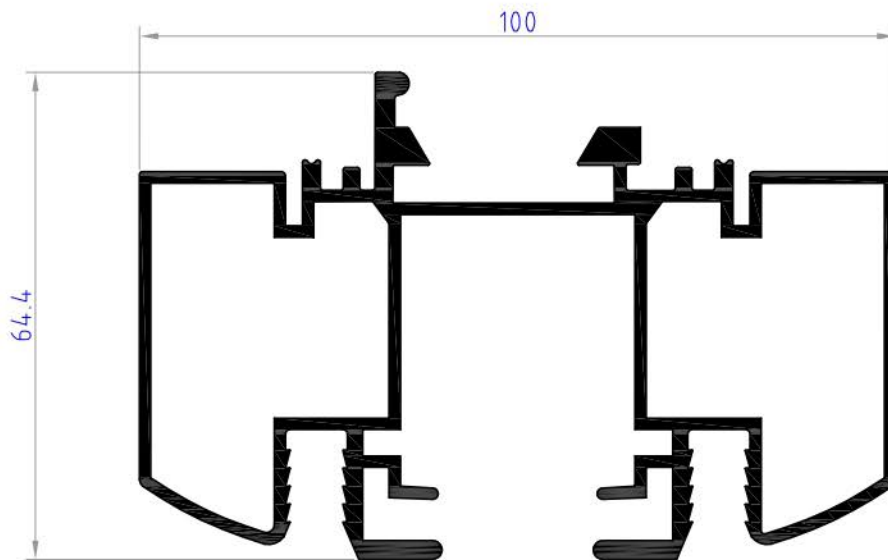

FUT 28
weight 2.138 kg/ml

OFFICE FURNITURE PROFILES

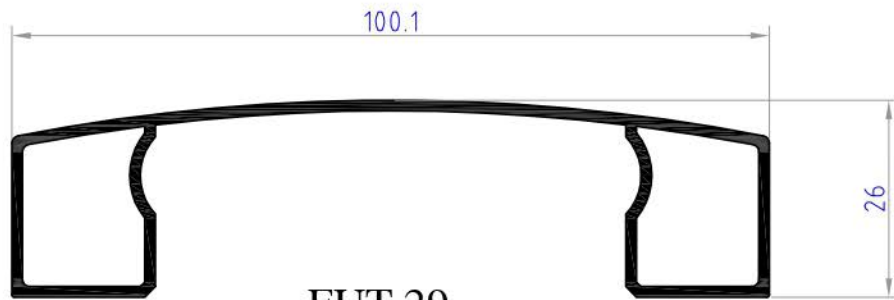

FUT 29
weight 0.780 kg/ml

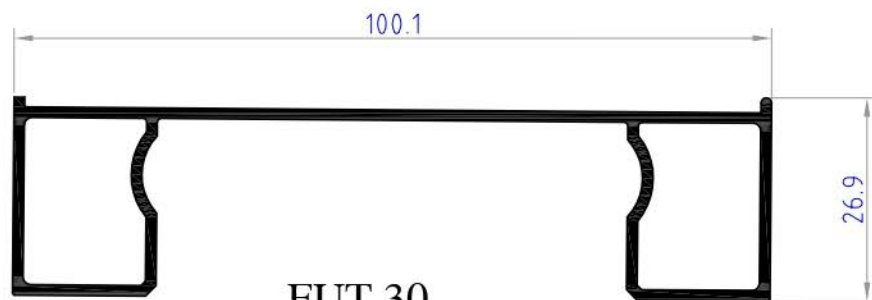

FUT 30
weight 0.796 kg/ml

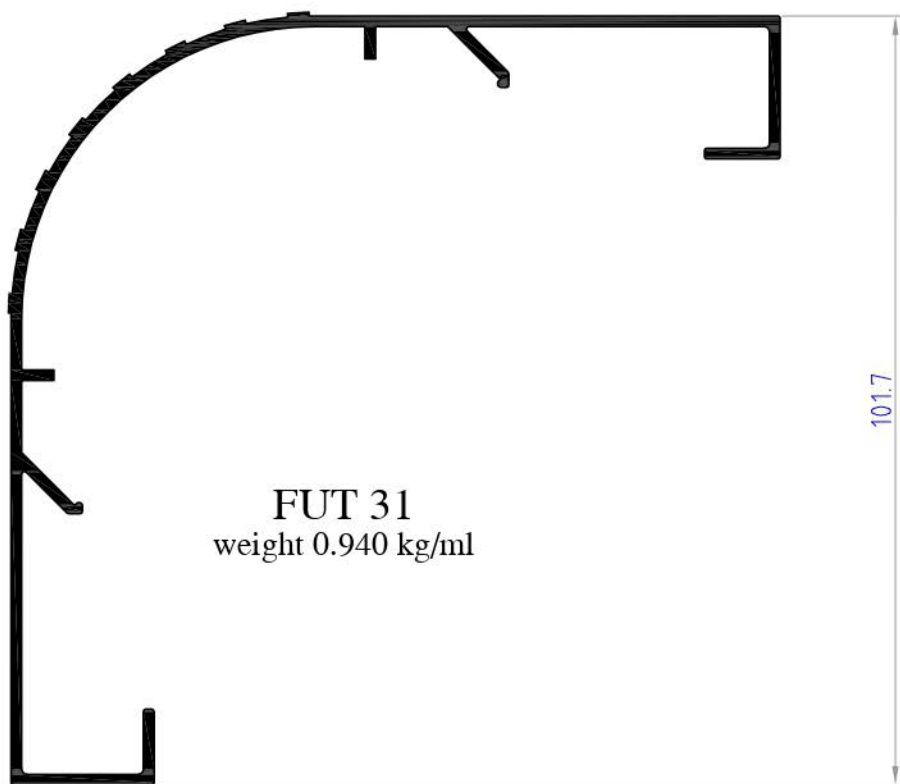

FUT 31
weight 0.940 kg/ml

OFFICE FURNITURE PROFILES

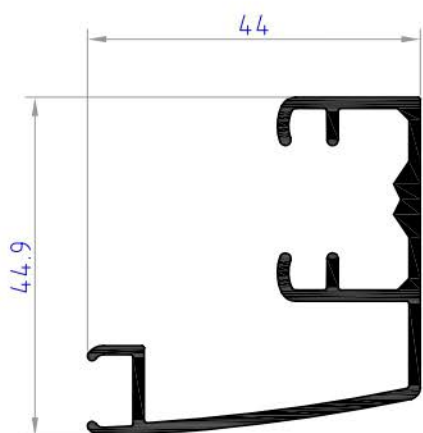

FUT 24
weight 0.584 kg/ml

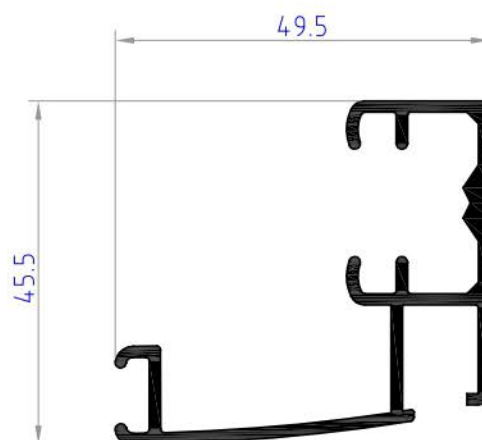

FUT 23
weight 0.641 kg/ml

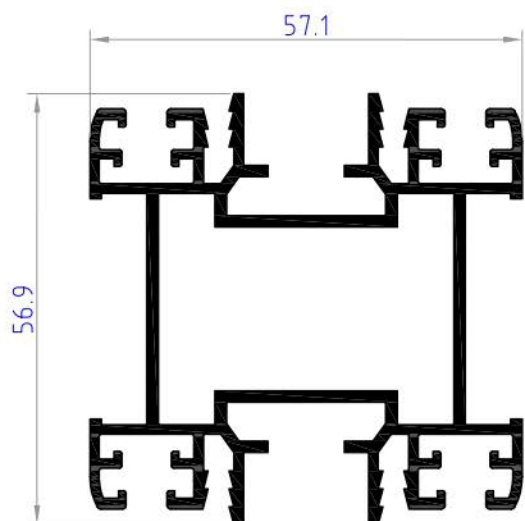

FUT 26
weight 1.391 kg/ml

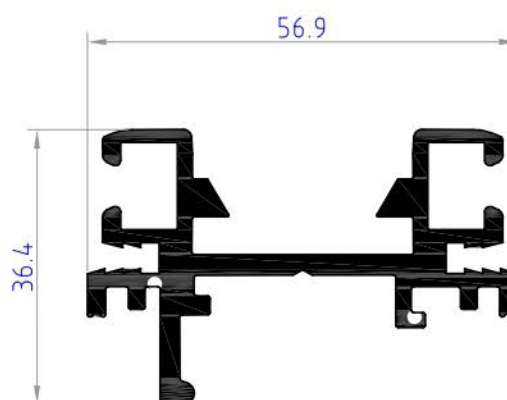

FUT 25
weight 1.165 kg/ml

OFFICE FURNITURE PROFILES

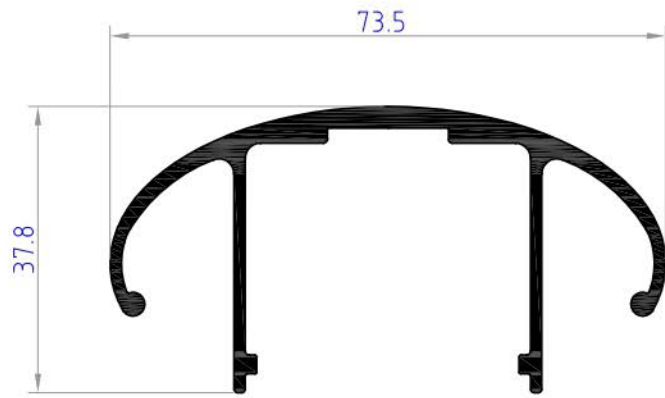
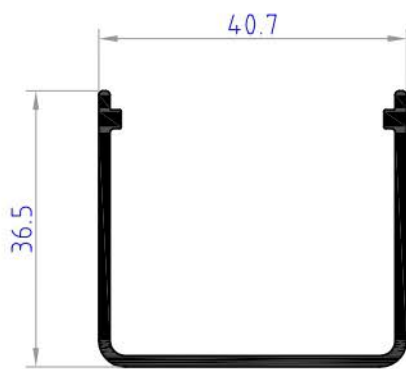
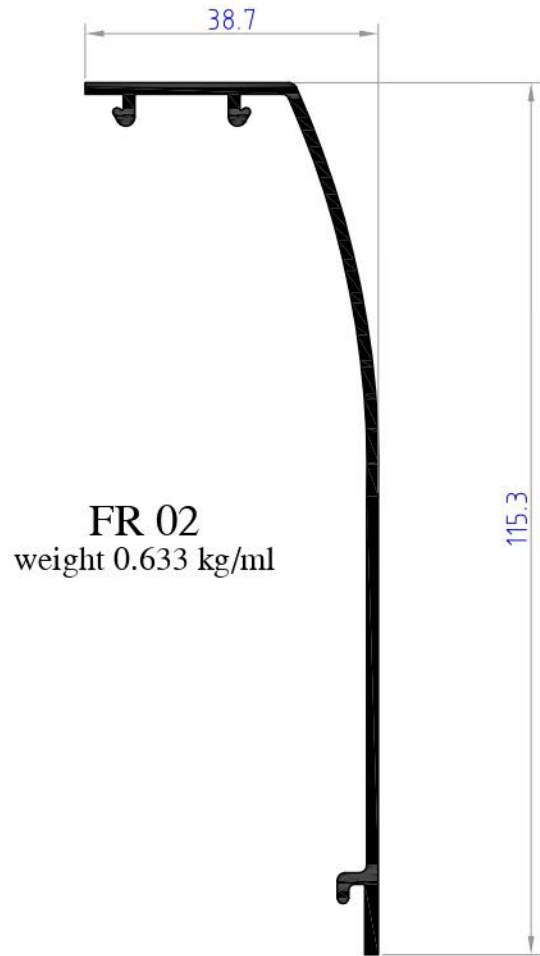
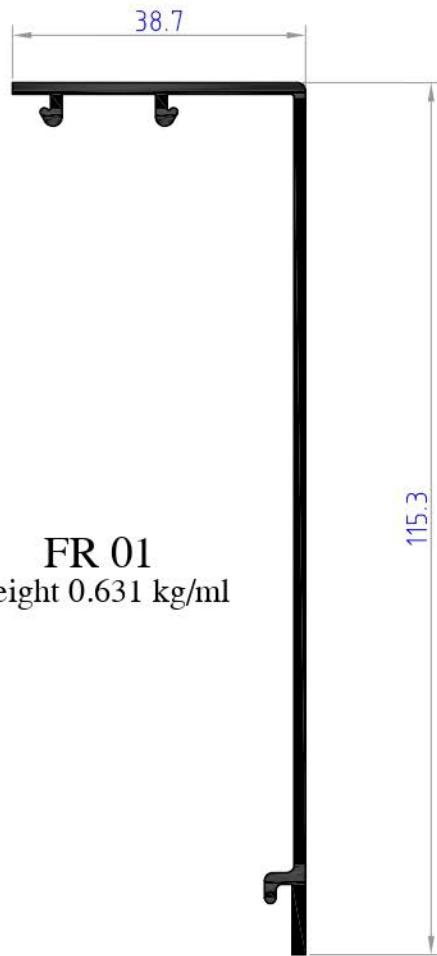

OFFICE FURNITURE PROFILES

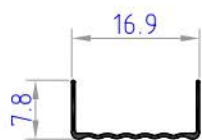

MSD01
weight 0.049 kg/ml

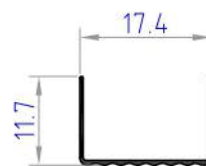

ST6016B
weight 0.065 kg/ml

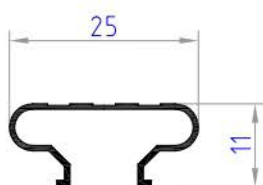

MY02
weight 0.096 kg/ml

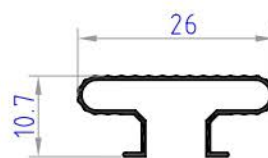

MY03
weight 0.085 kg/ml

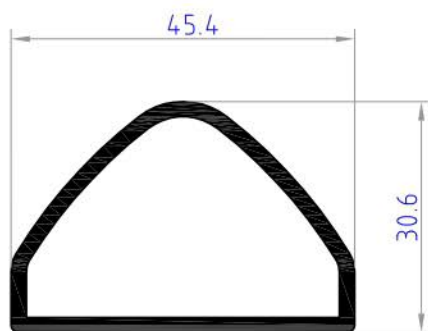

CH02
weight 0.641 kg/ml

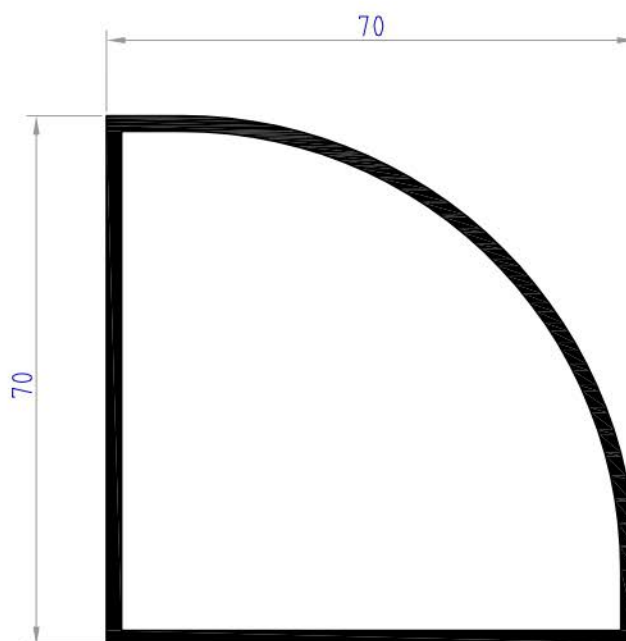

CH01
weight 1.293 kg/ml