













**HOME
FURNITURE
PROFILES**

HOME FURNITURE PROFILES

PROFILE NO.	SECTION	WEIGHT kg/ml
MBA01		0.239
MBA02		0.301
MBA03		0.454
MBA04		0.368
MBA05		0.429
MBA06		0.311
MBA07		0.285
MBA08		0.242
MBA09		0.271
MBA10		0.247

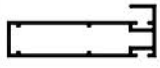
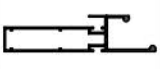
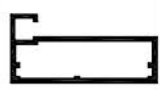
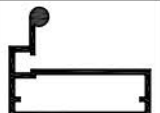
PROFILE NO.	SECTION	WEIGHT kg/ml
ER-60		0.370
ER-89		0.571
UT101		0.411
UT102		0.581
UT111		0.310
MAW01		0.595

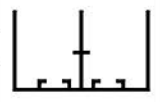
HOME FURNITURE PROFILES

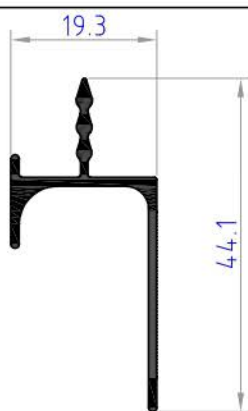

MBA01
weight 0.239 kg/ml



MBA02
weight 0.301 kg/ml

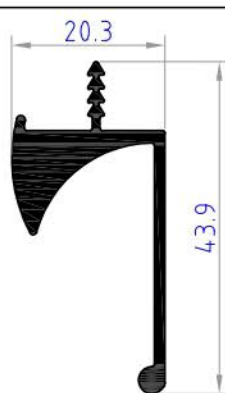

MBA03
weight 0.454 kg/ml



MBA04
weight 0.368 kg/ml

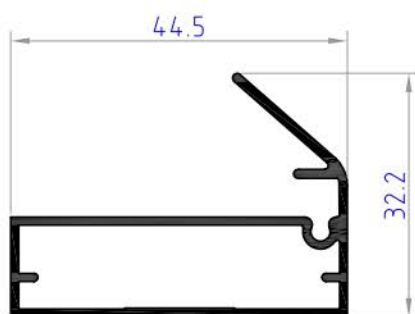

MBA05
weight 0.429 kg/ml

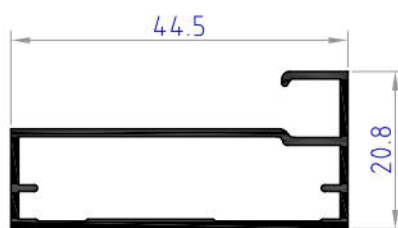

MBA06
weight 0.311 kg/ml

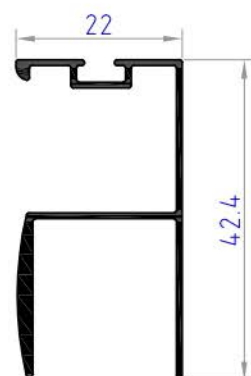

MBA07
weight 0.285 kg/ml



MBA08
weight 0.242 kg/ml

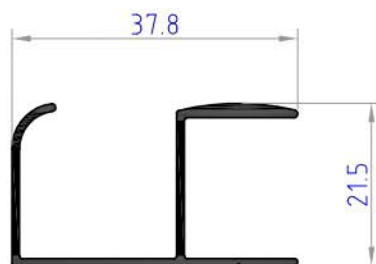

MBA09
weight 0.271 kg/ml

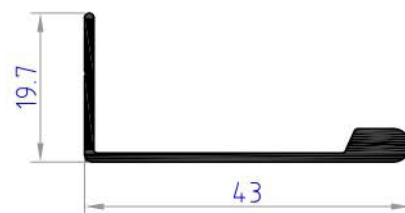

MBA10
weight 0.247 kg/ml

HOME FURNITURE PROFILES

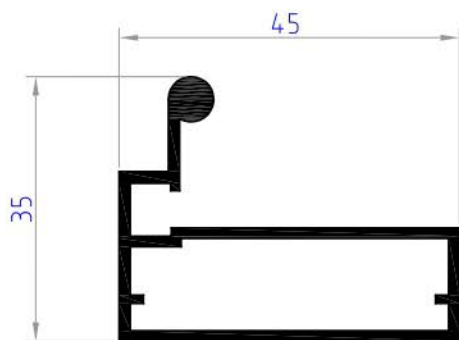

UT102
weight 0.581 kg/mL

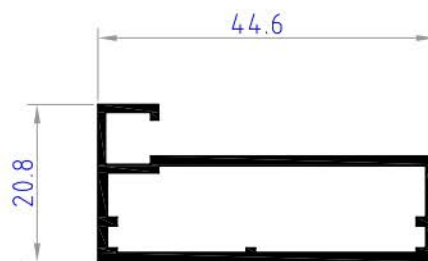

UT101
weight 0.411 kg/mL

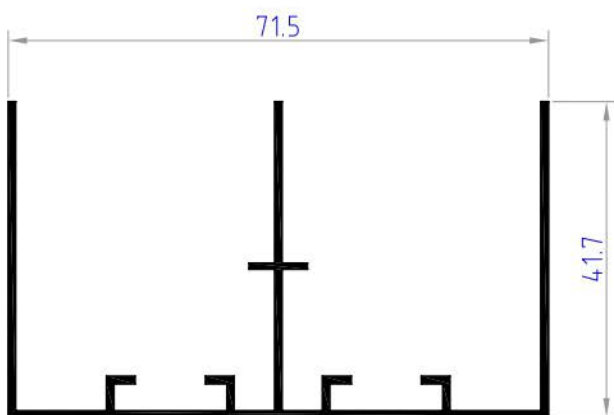

MAW01
weight 0.595 kg/ml

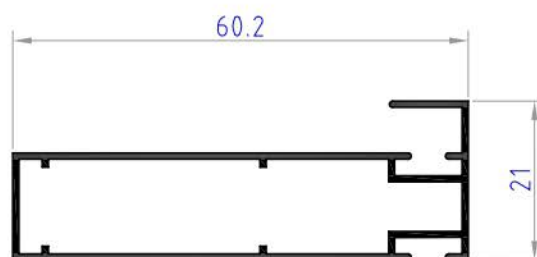

ER60
weight 0.370 kg/ml

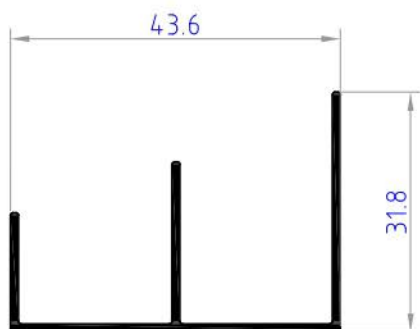

UT111
weight 0.310 kg/mL

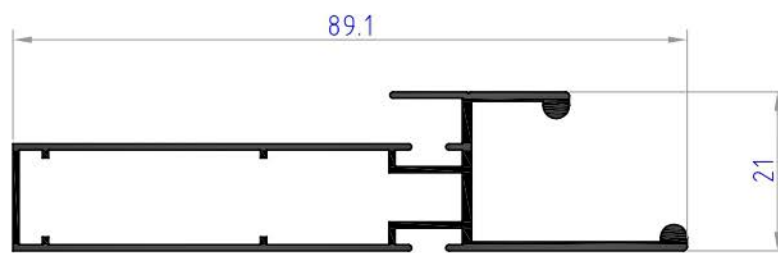

ER89
weight 0.571 kg/ml

HOME FURNITURE PROFILES

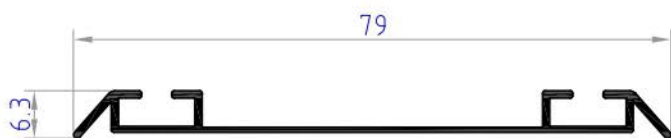

UT50
weight 0.221 kg/mL

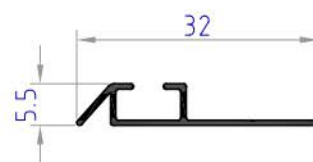

UT52
weight 0.087 kg/mL

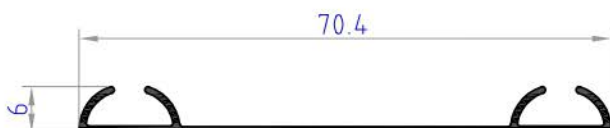

UT60
weight 0.215 kg/mL

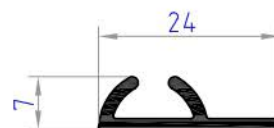

UT62
weight 0.154 kg/mL

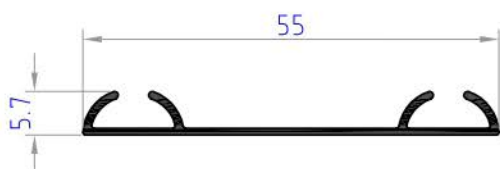

UT61
weight 0.190 kg/mL

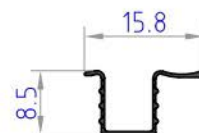

UT02
weight 0.052 kg/mL

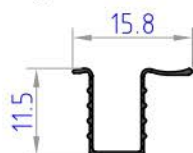

WK68
weight 0.056 kg/mL

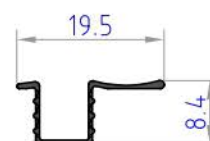

REM01
weight 0.053 kg/ml

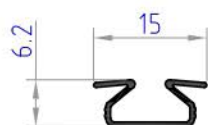

UT01
weight from 0.036 to 0.110 kg/mL

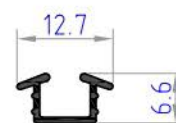

UT03
weight from 0.036 to 0.110 kg/mL